

ST 060 113 5892



- Schubrosetten Ø 70 mm
- Stichmaß 150 mm ± 13 mm
- Brauseabgang 3/8"
- mit Mengenregulierung

	Chrom	ST 060 113 5892-00
	Platin gebürstet	ST 060 113 5892-06
	Platin	ST 060 113 5892-08
	Dark Chrome	ST 060 113 5892-19
	Messing gebürstet (23kt Gold)	ST 060 113 5892-28
	Schwarz matt	ST 060 113 5892-33
	Champagne gebürstet (22kt Gold)	ST 060 113 5892-46
	Champagne (22kt Gold)	ST 060 113 5892-47
	Chrom gebürstet	ST 060 113 5892-93
	Dark Platinum gebürstet	ST 060 113 5892-99

Einzelkomponenten dieses Sets

Für dieses Set benötigen Sie folgende Komponenten

1x 11 431 892-00













1x 34 443 979-00



ST 060 113 5892



	Chrom	11 431 892-00
	Platin gebürstet	11 431 892-06
	Platin	11 431 892-08
	Dark Chrome	11 431 892-19
	Messing gebürstet (23kt Gold)	11 431 892-28
	Schwarz matt	11 431 892-33
	Champagne gebürstet (22kt Gold)	11 431 892-46
	Champagne (22kt Gold)	11 431 892-47
	Chrom gebürstet	11 431 892-93
	Dark Platinum gebürstet	11 431 892-99

ST 060 113 5892

mm [inches]



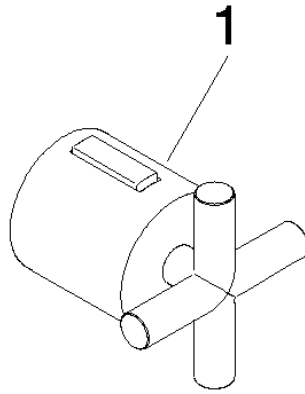

- Schubrosetten Ø 70 mm
 - Stichmaß 150 mm ± 13 mm
 - Brauseabgang 3/8"
 - mit Mengenregulierung
- Eigensicher gegen Rückfließen.**

Eigensicher gegen Rückfließen.

	Chrom	34 443 979-00
	Platin gebürstet	34 443 979-06
	Platin	34 443 979-08
	Dark Chrome	34 443 979-19
	Messing gebürstet (23kt Gold)	34 443 979-28
	Schwarz matt	34 443 979-33
	Champagne gebürstet (22kt Gold)	34 443 979-46
	Champagne (22kt Gold)	34 443 979-47
	Chrom gebürstet	34 443 979-93
	Dark Platin gebürstet	34 443 979-99

ST 060 113 5892

Benötigtes Zubehör



**TARA Mengenreguliergriff -
Chrom**

11 431 892-00

ST 060 113 5892

mm [inches]

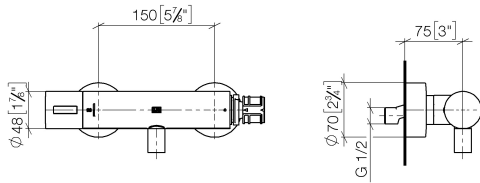

Durchflussdiagramm

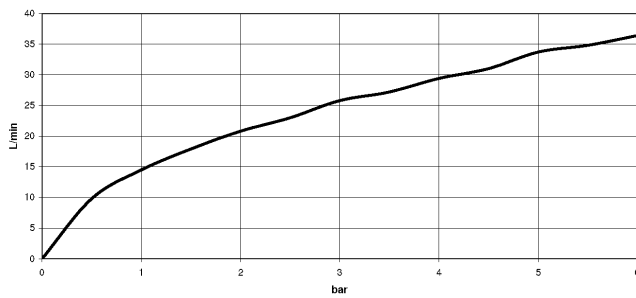

Zertifikate

Belgaqua_22_281_2 LGA_29986.
7_5.

WRAS_2204005.

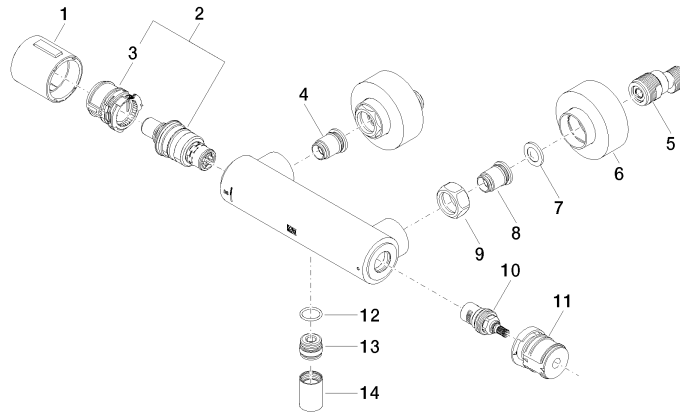

Ersatzteilstückliste

Nr.	Artikelnummer	Benennung	Verbaumenge	Lieferzeit
1	90 17 33 015 00-00	Griff	1	10
2	90 15 02 070 00 90	Kartusche	1	2
3	90 30 40 010 00 90	Regler	1	2
4	04 31 20 530 00 90	Einsatz	1	2
5	04 11 04 030 00 90	Anschluss	2	2
6	90 31 20 512 00-00	Rosette	2	2
7	09 29 30 050 90	Sieb	2	2
8	04 31 20 540 00 90	Einsatz	1	2
9	09 24 77 008-00	Mutter	2	10
10	90 90 03 236 00 90	Oberteil	1	2
11	90 30 40 017 00 90	Aufnahme	1	2
12	90 14 10 010 00 90	Dichtung	1	2
13	09 31 20 511-00	Nippel	1	10
14	90 21 02 069 00-00	Haube	1	10